

# Turmdrehkran 13 HM

Tower Crane / Grue à tour / Gru a torre  
Grúa torre / Guindaste de torre

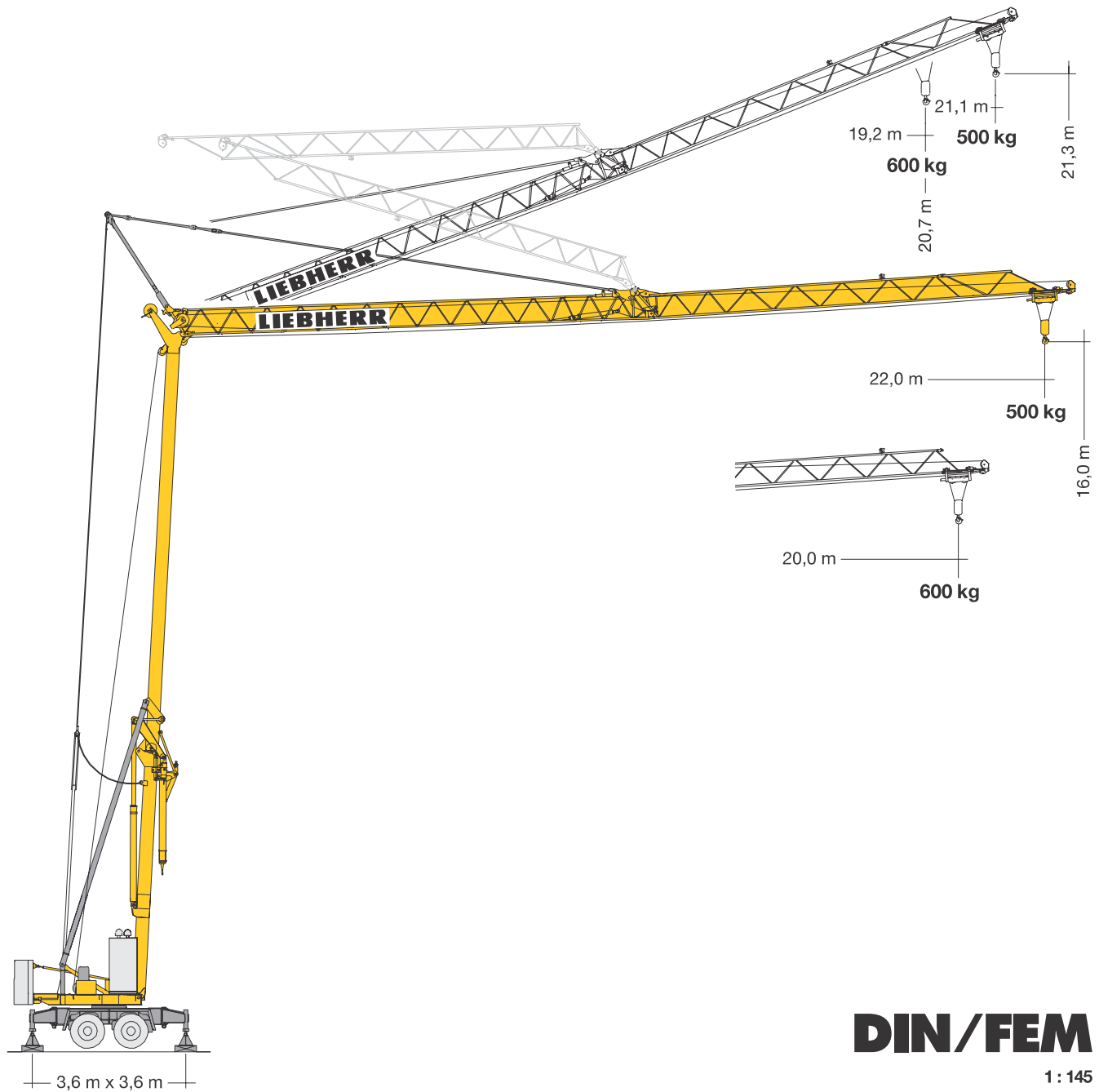

**DIN/FEM**

1 : 145

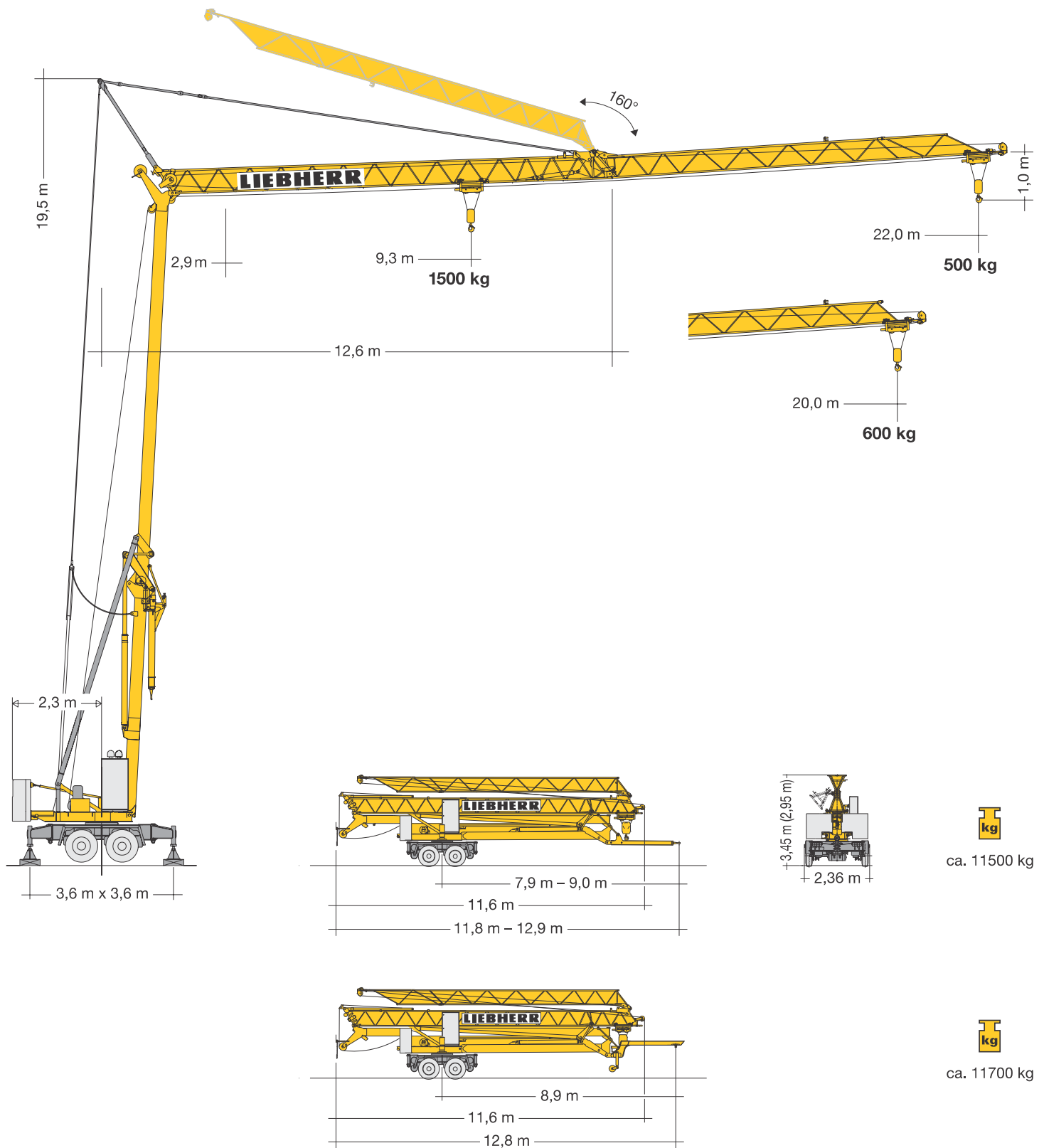

## Gewicht

Weight / Poids / Peso / Peso / Pesos

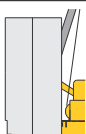

1 x 4600 kg

r = 2,3 m



6600 kg

# Ausladung und Tragfähigkeit

Radius and capacity / Portée et charge / Sbraccio e portata / Alcances y cargas / Alcance e capacidade de carga

m	m / kg		m/kg												
			10,0	11,0	12,0	13,0	14,0	15,0	16,0	17,0	18,0	19,0	20,0	21,0	22,0
22,0	2,9-9,3 1500		1360	1200	1080	970	890	810	750	690	650	600	570	530	500
20,0	2,9-9,7 1500		1440	1270	1140	1030	940	860	790	740	690	640	600		
11,6	2,9-10,7 1500		1500	1460	1370										



## Auslegersteilstellung 20°

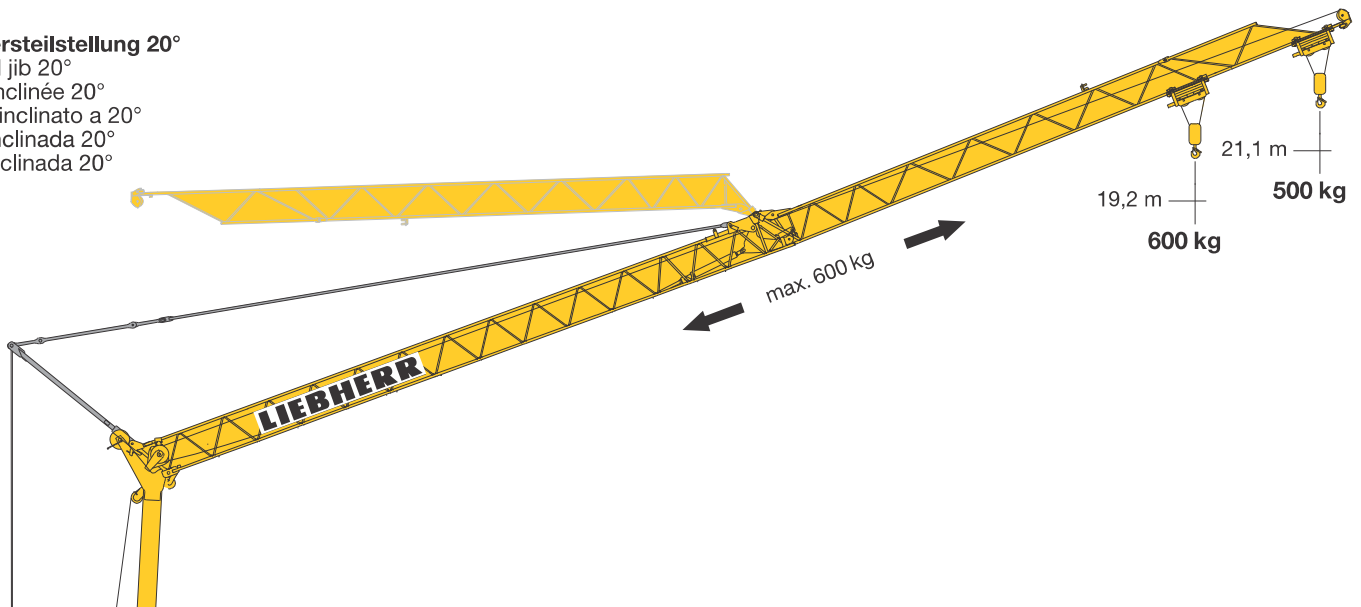

Elevated jib 20°  
Flèche inclinée 20°  
Braccio inclinato a 20°  
Pluma inclinada 20°  
Lança inclinada 20°



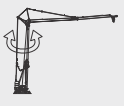

# Antriebe

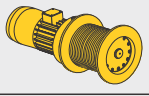
Driving units / Mécanismes d'entraînement / Azionamenti / Mecanismos / Mecanismos

	230 V	400 V	
	0 ↔ 1,0 U/min sl./min tr./min	0 ↔ 1,0 U/min sl./min tr./min	1,1 kW FU
	6,0 ↔ 12,0 m/min	12,0 / 24,0 m/min	0,6 / 1,2 kW
	ca. 160°/min.	ca. 160°/min.	3,0 kW

	Stufe / Step / Cran Marcia / Velocidad Velocidade	kg	m/min
3,5 kW	<b>230 V FU</b>		
	1	1500	2,5
	2	1500	5,0
	3	750	10,0
	<b>400 V KL</b>		
	1	1500	4,0
	<b>400 V FU</b>		
	1	1500	2,5
	2	1500	12,5
	3	750	25,0

BGL		C.0.05.0012
-----	---	-------------

	230 V	Hz	A
30,0 m	3 x 2,5 mm <sup>2</sup>	50	16,0

	400 V	Hz	kVA
100,0 m	5 x 4 mm <sup>2</sup> KL/FU	50	8,0

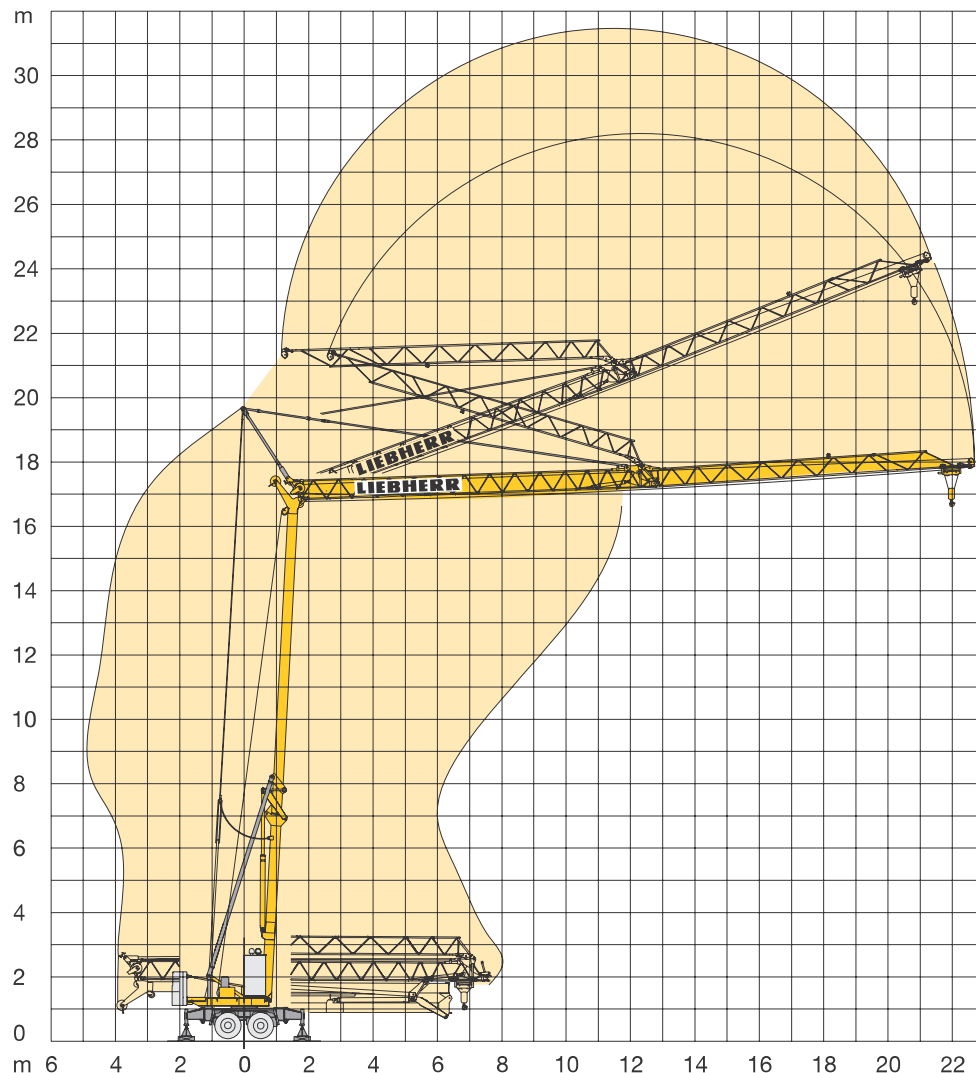

## Kolli-Liste

Packing List / Liste de colisage / Lista dei colli / Lista de contenido / Lista de embalagem

Pos. Item Rep. Voce Pos. Ref.	Anz. Qty. Qte Qta. Cant. Cant.		L (m)	B (m)	H (m)	kg
1	1	<b>Ausleger-Verlängerung 20,0 m – 22,0 m</b> Jib extension / Rallonge de la flèche Elemento estensione braccio Prolongación de pluma / Extensão da lança	3,00	0,71	0,60	35



**Konstruktionsänderungen vorbehalten!**  
 Subject to alterations! / Sous réserves de modifications!  
 Si fa riserva di modifiche! / ¡Sujeto a modificaciones!  
 Salvo modificação da construçao!

**Sämtliche Angaben erfolgen ohne Gewähr.** / This information is supplied without liability.  
 Ces renseignements sont sans garantie. / Le indicazioni contenute si intendono salvo errori ed omissioni.  
 Declinamos toda responsabilidad derivada de la información proporcionada.  
 Declinamos qualquer responsabilidade quanto à informação fornecida.